

High Speed IGBT in Trench and Fieldstop Technology

Electrical Features:

- 1200V 150A, $V_{CE(sat)} = 1.7V@25^{\circ}C$
- High RBSOA Capability
- Trench/FS Technology
- Low Reverse-recovery Losses
- High SC Capability



Applications:

- Motor Drives
- Solar Applications
- UPS Systems
- Commercial Electric Vehicles
- Wind Turbines

Mechanical Features:

- High Power and Thermal Cycling Capability
- High Power Density
- PressFIT Contact Technology
- Isolated Base Plate

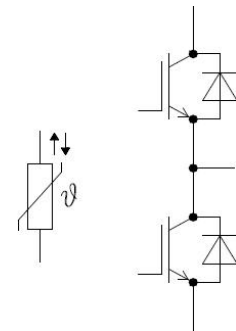

Equivalent circuit

Key Performance and Package Parameters

Type	V_{CE}	I_C	$V_{CEsat}, T_{vj}=25^{\circ}C$	T_{vjmax}	Marking	Package
DKM150GB12X7T	1200V	150A	1.7V	150°C	DKM150GB12X7T	34mm

Maximum Ratings and Characteristics

Absolute Maximum Ratings at $T_c = 25^{\circ}C$ (unless otherwise specified)

Items	Symbols	Values	Units	Remarks
Collector-Emitter voltage	V_{CES}	1200	V	
Gate-Emitter voltage	V_{GES}	± 30	V	
DC Collector Current	I_C	150	A	$T_c = 100^{\circ}C$
Pulsed Collector Current	I_{CP}	300	A	Note *1
Diode Forward Current	I_F	150	A	
Short Circuit Withstand Time	T_{SC}	10	μs	$V_{CC} \leq 600V, V_{GE} = 15V$ $T_{vj} \leq 150^{\circ}C$
Operating Junction Temperature	T_{vj}	-40 ~ +150	$^{\circ}C$	
Storage Temperature	T_{stg}	-40 ~ +125	$^{\circ}C$	

Note *1 : Pulse width limited by T_{vjmax} .

Electrical characteristics (unless otherwise specified)

IGBT

Description	Symbols	Conditions		Values			Unit
				Min	Typ	Max	
Zero Gate Voltage Collector Current	I_{CES}	$V_{CE} = 1200V, V_{GE} = 0V$ $T_{vj} = 25^{\circ}C$				200	μA
Gate-Emitter Leakage Current	I_{GES}	$V_{CE} = 0V, V = 20V, T_{vj} = 25^{\circ}C$				± 300	nA
Gate-Emitter Threshold Voltage	$V_{GE(th)}$	$V_{CE} = V_{GE}, I_C = 150mA$		6.2	6.7	7.2	V
Collector-Emitter Saturation Voltage	$V_{CE(sat)}$	$V_{GE} = 15V$ $I_C = 150A$	$T_{vj} = 25^{\circ}C$		1.7	2.2	V
			$T_{vj} = 125^{\circ}C$		2.1		
			$T_{vj} = 150^{\circ}C$		2.2		
Input Capacitance	C_{ies}	$V_{CE} = 25V, V_{GE} = 0V$			40		nF
Reverse Transfer Capacitance	C_{res}	$f = 1MHz$			0.19		nF
Gate Charge	Q_G	$V_{CC} = 600V, V_{GE} = 15V$			1450		nC
Internal Gate Resistor	R_{Gint}	$T_{vj} = 25^{\circ}C$			2.8		Ω
Turn-On Delay Time, Inductive load	$t_{d(on)}$	$V_{CC} = 600V$ $I_C = 150A$ $V_{GE} = 15V$ $R_G = 10\Omega$	$T_{vj} = 25^{\circ}C$		0.36		μs
			$T_{vj} = 125^{\circ}C$		0.39		
			$T_{vj} = 150^{\circ}C$		0.40		
Rise Time, Inductive load	t_r		$T_{vj} = 25^{\circ}C$		0.13		μs
			$T_{vj} = 125^{\circ}C$		0.15		
			$T_{vj} = 150^{\circ}C$		0.16		
Turn-Off Delay Time, Inductive load	$t_{d(off)}$		$T_{vj} = 25^{\circ}C$		0.40		μs
			$T_{vj} = 125^{\circ}C$		0.44		
			$T_{vj} = 150^{\circ}C$		0.45		
Fall Time, Inductive load	t_f	$T_{vj} = 25^{\circ}C$		0.14		μs	
		$T_{vj} = 125^{\circ}C$		0.23			
		$T_{vj} = 150^{\circ}C$		0.25			
Turn-On Energy	E_{on}	$T_{vj} = 25^{\circ}C$		14.1		mJ	
		$T_{vj} = 125^{\circ}C$		20.9			
		$T_{vj} = 150^{\circ}C$		23.5			
Turn-Off Energy	E_{off}	$T_{vj} = 25^{\circ}C$		8.9		mJ	
		$T_{vj} = 125^{\circ}C$		11.1			
		$T_{vj} = 150^{\circ}C$		12.0			

Diode

Description	Symbols	Conditions	Values			Unit
			Min	Typ	Max	
Forward Voltage	V_F	$I_F = 150A, V_{GE} = 0V$	$T_{vj} = 25^\circ C$	2.04	2.7	V
			$T_{vj} = 125^\circ C$	1.62		
			$T_{vj} = 150^\circ C$	1.56		
Recovery Charge	Q_r	$I_F = 150A, V_R = 600V$ $-di_f/dt = 1200A/us$ $V_{GE} = -15V$	$T_{vj} = 25^\circ C$	5.07		μC
			$T_{vj} = 125^\circ C$	15.99		
			$T_{vj} = 150^\circ C$	19.33		
Reverse Recovery Energy	E_{rec}	$I_F = 150A, V_R = 600V$ $-di_f/dt = 1200A/us$ $V_{GE} = -15V$	$T_{vj} = 25^\circ C$	1.88		mJ
			$T_{vj} = 125^\circ C$	5.76		
			$T_{vj} = 150^\circ C$	6.89		

Thermal resistance

Items	Symbols	Values			Unit
		Min	Typ	Max	
Thermal Resistance, Per IGBT Junction to Case	$R_{th(j-c)}$			0.3	K/W
Thermal Resistance, Per Diodes Junction to Case	$R_{th(j-c)}$			0.4	

Module

Description	Symbols	Conditions	Values	Unit
Isolation Test Voltage	V_{ISOL}	RMS, $f = 50Hz, t = 1min$	4.0	KV
Material of Module Base plat			Cu	
Internal Isolation			Al_2O_3	
Creepage Distance	d_{Creep}	Terminal to terminal	20.1	mm
Clearance	d_{Clear}	Terminal to terminal	9.5	mm
Comparative Tracking Index	CTI		200	

Description	Symbols	Conditions	Values			Unit
			Min	Typ	Max	
Stray Inductance Module	L_{sCE}			29.2		nH
Module Lead Resistance , Terminals-Chip	$R_{CC'+EE'}$	$T_C = 25^\circ C, \text{ Per switch}$		0.66		$m\Omega$
Mounting Torque for Module Mounting	M	Screw M5	3.0		5.0	Nm
Weight	G			156		g

Output characteristic (typical), IGBT, Inverter

$I_C = f(V_{CE})$

$V_{GE} = 15V$

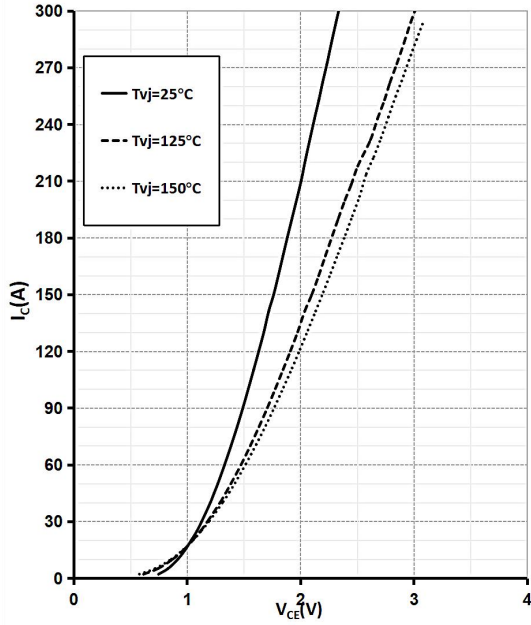

Output characteristic (typical), IGBT, Inverter

$I_C = f(V_{CE})$

$T_{vj} = 150^{\circ}C$

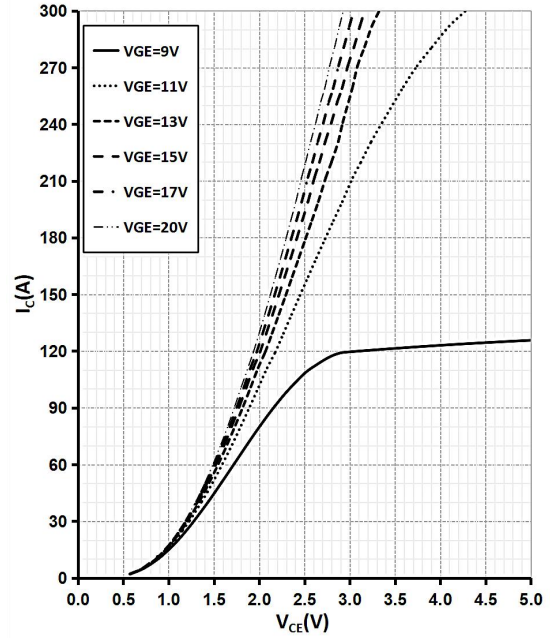

Switching losses (typical), IGBT, Inverter

$E = f(I_C)$

$R_{Goff} = 10\Omega, R_{Gon} = 10\Omega, V_{GE} = \pm 15V, V_{CC} = 600V$

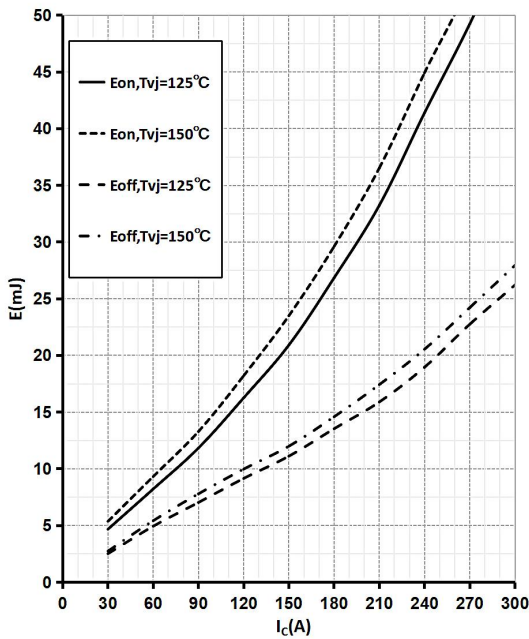

Switching losses (typical), IGBT, Inverter

$E = f(R_G)$

$V_{GE} = 15V, I_C = 150A, V_{CC} = 600V$

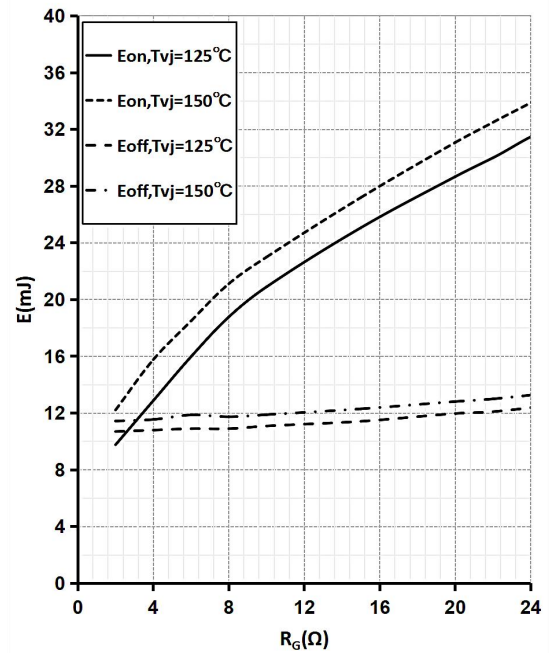

Forward characteristic (typical), Diode, Inverter

$I_F = f(V_F)$

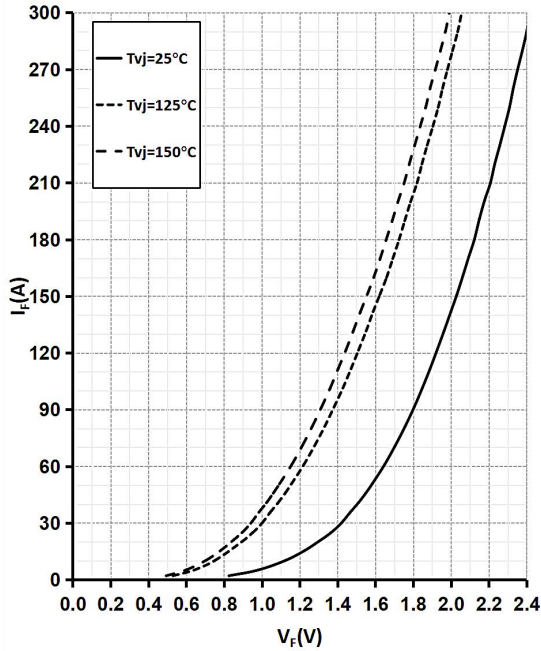

Switching losses (typical), Diode, Inverter

$E_{rec} = f(I_F)$

$R_{Gon} = 10\Omega, V_{CC} = 600V$

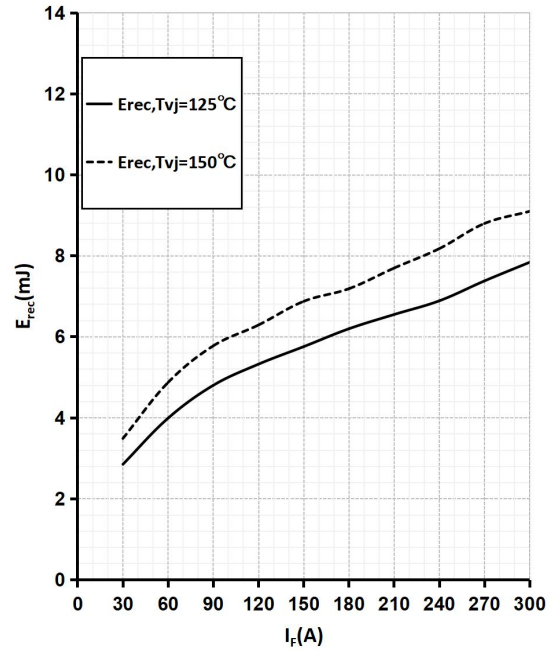

Reverse bias safe operating area (RBSOA), IGBT, Inverter

$I_C = f(V_{CE})$

$R_{Goff} = 10\Omega, V_{GE} = \pm 15V, T_{vj} = 150^\circ\text{C}$

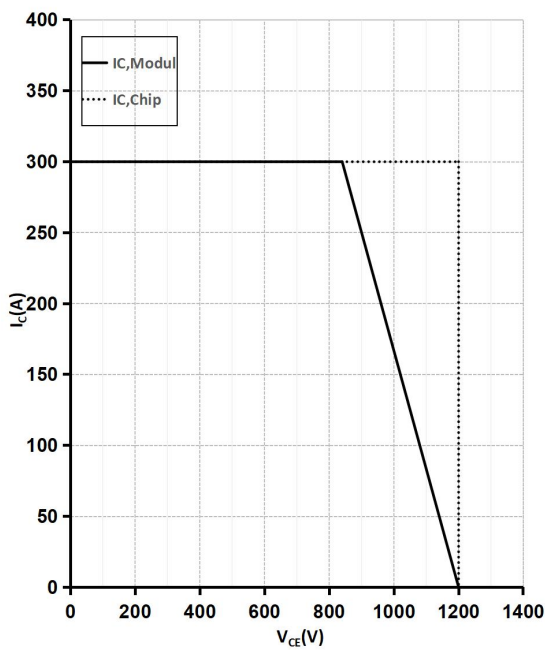

Package Dimension

Dimensions in Millimeters

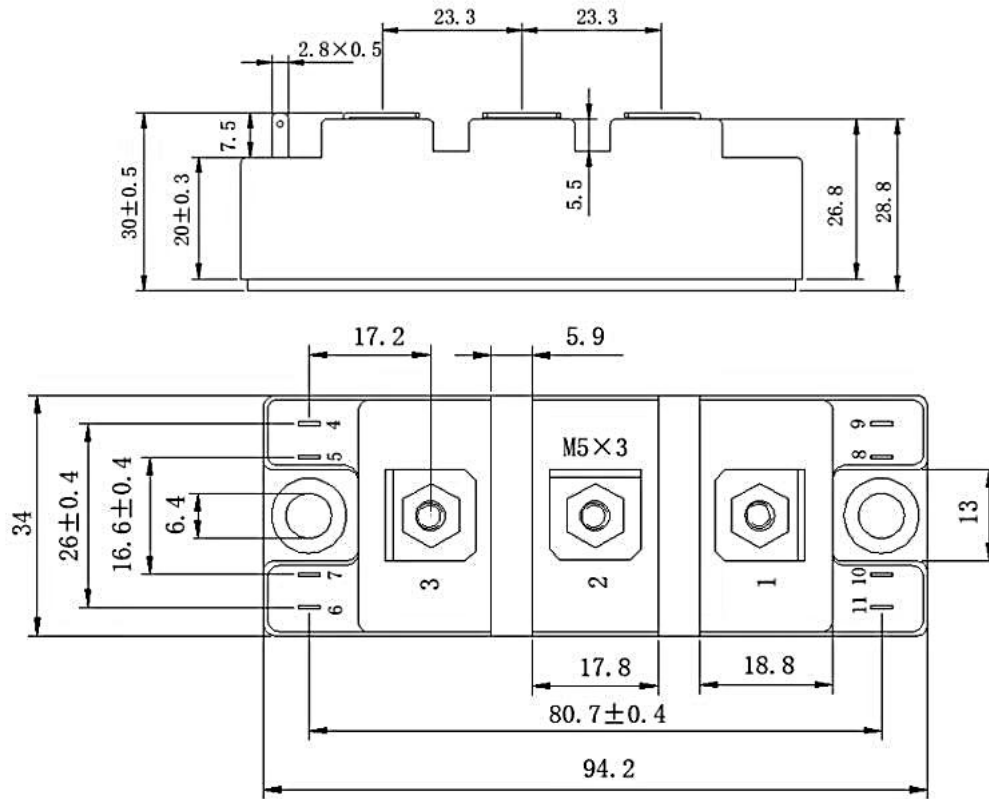

Internal Circuit

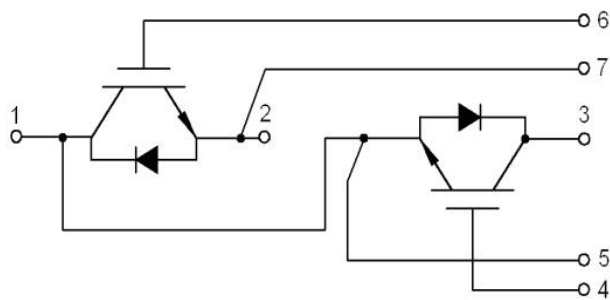

Revision History

Revision	Date	Subjects (major changes since last revision)
0.1	2024-04-10	Preliminary version

The information given herein shall be not regarded as a guarantee of conditions or characteristics . For any examples, hints or any typical values stated herein and/or any information regarding the application of the product, Drvtek hereby disclaims any and all warranties and liabilities of any kind, including without limitation warranties of non-infringement of intellectual property rights of any third party.

In addition, any information given herein is subject to customer’s compliance with its obligations stated herein and any applicable legal requirements, norms and standards concerning customer’s products and any use of the product of Drvtek in customer’s applications.

The data contained herein is exclusively intended for technically trained staff. It is the responsibility of customer to evaluate the suitability of the product for the intended application and the completeness of the product information given herein for such application.

For further information on the product, technology, delivery, conditions and prices please contact Drvtek (www.Drvtek.com).

Warnings

Due to technical requirements products may contain dangerous substances. For information on the types in question please contact Drvtek.

Except as otherwise approved by Drvtek in a written document, Drvtek products may not be used in any applications where a failure of the product or any consequences of the use thereof can reasonably be expected to result in personal injury.