

650V 50A CoolFAST™ 7 Technology IGBT

Features:

- Low Switching Power Loss
- Low Switching Surge and Noise
- Advanced Field Stop Technology
- Low EMI
- Maximum Junction Temperature 175°C
- Qualified According to JEDEC For Target Applications
- Pb-free Lead Plating, Halogen-free Mold Compound, RoHS Compliant

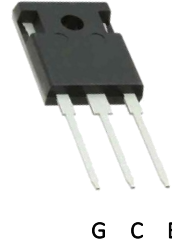

Applications:

- Industrial UPS
- Welding Machine
- Solar Converters
- Energy Storage
- EV Charger

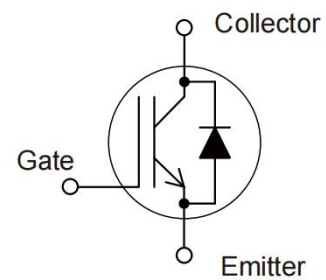

Key Performance and Package Parameters

Type	V _{CE}	I _C	V _{CEsat} , T _{vj} =25°C	T _{vjmax}	Marking	Package
DKW50N65DX7	650V	50A	1.55 V	175°C	DKW50N65DX7	TO247-3

Maximum Ratings and Characteristics

Absolute Maximum Ratings at T_{vj}= 25°C (unless otherwise specified)

Items	Symbols	Value	Units
Collector-emitter voltage	V _{CES}	650	V
Gate-emitter voltage	V _{GES}	±20	V
Transient gate-emitter voltage (t _p ≤ 10μs, D < 0.010)		±30	
DC collector current, limited by T _{vjmax} T _C = 25°C T _C = 100°C	I _C	90	A
		50	
Pulsed collector current, t _p limited by T _{vjmax}	I _{CP}	200	A
Diode forward current, limited by T _{vjmax} T _C = 25°C T _C = 100°C	I _F	110	A
		50	
Diode Pulsed collector current, t _p limited by T _{vjmax}	I _{FP}	200	A
Short circuit withstand time, V _{GE} = 15V, V _{CE} ≤ 400V	T _{SC}	5	μs
IGBT max. power dissipation	P _{D_IGBT}	365	W
FWD max. power dissipation	P _{D_FWD}	300	W
Operating junction temperature	T _{vj}	-40 ~ +175	°C
Storage temperature	T _{stg}	-55 ~ +175	°C

Electrical Characteristics at $T_{vj}= 25^{\circ}\text{C}$ (unless otherwise specified)

Description	Symbols	Conditions	Characteristics			Unit
			Min	Typ	Max	
Collector-emitter breakdown voltage	$V_{(BR)CES}$	$V_{GE}= 0\text{V}, I_C= 0.25\text{mA}$	650	-	-	V
Zero gate voltage collector current	I_{CES}	$V_{CE}= 650\text{V}, V_{GE}= 0\text{V}$	-	-	200	μA
Gate-emitter leakage current	I_{GES}	$V_{CE}= 0\text{V}, V_{GE}= \pm 20\text{V}$	-	-	± 200	nA
Gate-emitter threshold voltage	$V_{GE(th)}$	$V_{CE}= V_{GE}, I_C= 250\mu\text{A}$	5.0	5.8	6.6	V
Collector-emitter saturation voltage	$V_{CE(sat)}$	$V_{GE}= 15\text{V}, I_C= 50\text{A}$	-	1.55	2.25	V
		$T_{vj}= 25^{\circ}\text{C}$ $T_{vj}= 175^{\circ}\text{C}$	-	2.0		
Input capacitance	C_{ies}	$V_{CE}= 25\text{V}, V_{GE}= 0\text{V}$ $f= 1\text{MHz}$	-	5805	-	pF
Output capacitance	C_{oes}		-	164	-	pF
Reverse transfer capacitance	C_{res}		-	57	-	pF
Gate charge	Q_G	$V_{CC}= 520\text{V}, I_C= 50\text{A}, V_{GE}= 15\text{V}$	-	223	-	nC
Forward voltage drop	V_F	$I_F= 50\text{A}$	-	1.55	3.0	V
		$T_{vj}= 25^{\circ}\text{C}$ $T_{vj}= 175^{\circ}\text{C}$	-	1.3		

Switching Characteristics at $T_{vj}= 25^{\circ}\text{C}$

Description	Symbols	Conditions	Characteristics			Unit
			Min	Typ	Max	
IGBT Characteristics						
Turn-on delay time	$t_{d(on)}$	$V_{CC}= 400\text{V}$ $I_C= 50\text{A}$ $V_{GE}= 15\text{V}$ $R_G= 10\Omega$ Inductive load	-	42	-	ns
Rise time	t_r		-	77	-	ns
Turn-off delay time	$t_{d(off)}$		-	153	-	ns
Fall time	t_f		-	31	-	ns
Turn-on energy	E_{on}		-	1.9	-	mJ
Turn-off energy	E_{off}		-	0.5	-	mJ
Total switching energy	E_{ts}		-	2.4	-	mJ
Diode Characteristics						
Diode reverse recovery time	t_{rr}	$V_{CC}= 400\text{V}$	-	106	-	ns
Diode reverse recovery charge	Q_{rr}	$I_F= 50\text{A}$	-	0.8	-	μC
Diode peak reverse recovery current	I_{rrm}	$di_F/dt= 500\text{A}/\mu\text{s}$	-	11.2	-	A

Switching Characteristics at $T_{vj}= 175^{\circ}\text{C}$

Description	Symbols	Conditions	Characteristics			Unit
			Min	Typ	Max	
IGBT Characteristics						
Turn-on delay time	$t_{d(on)}$	$V_{CC}= 400\text{V}$ $I_C= 50\text{A}$ $V_{GE}= 15\text{V}$ $R_G= 10\Omega$ Inductive load	-	36	-	ns
Rise time	t_r		-	73	-	ns
Turn-off delay time	$t_{d(off)}$		-	176	-	ns
Fall time	t_f		-	41	-	ns
Turn-on energy	E_{on}		-	1.9	-	mJ
Turn-off energy	E_{off}		-	0.8	-	mJ
Total switching energy	E_{ts}		-	2.7	-	mJ
Diode Characteristics						
Diode reverse recovery time	t_{rr}	$V_{CC}= 400\text{V}$	-	199	-	ns
Diode reverse recovery charge	Q_{rr}	$I_F= 50\text{A}$	-	3.7	-	μC
Diode peak reverse recovery current	I_{rrm}	$di_F/dt= 500\text{A}/\mu\text{s}$	-	30	-	A

Thermal Resistance

Items	Symbols	Characteristics			Unit
		Min	Typ	Max	
Thermal resistance, junction-ambient	$R_{th(j-a)}$	-	-	50	°C /W
Thermal resistance, IGBT junction to case	$R_{th(j-c)}$	-	-	0.41	
Thermal resistance, diodes junction to case	$R_{th(j-c)}$	-	-	0.5	

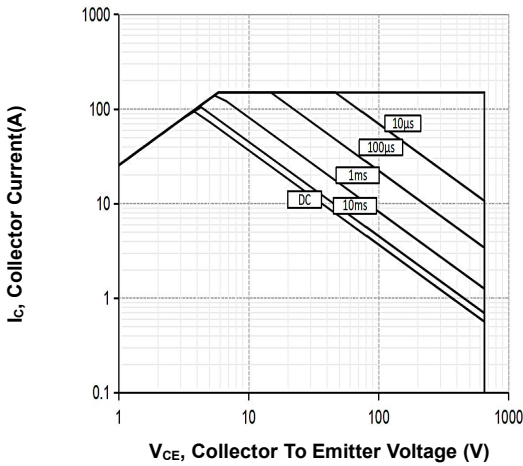

Figure 1. Forward bias safe operating area
($D = 0$, $T_c = 25^\circ\text{C}$, $T_{vj} \leq 175^\circ\text{C}$; $V_{GE} = 15\text{V}$)

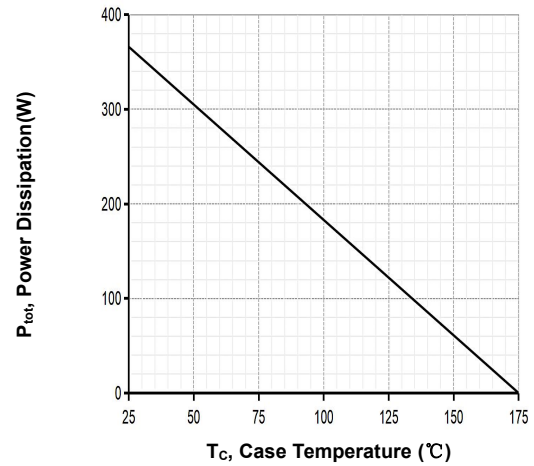

Figure 2. Power dissipation vs. case temperature
($T_{vj} \leq 175^\circ\text{C}$)

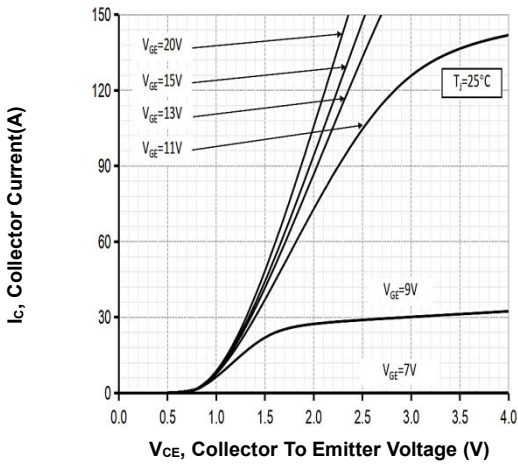

Figure 3. Typical output characteristic
($T_{vj} = 25^\circ\text{C}$)

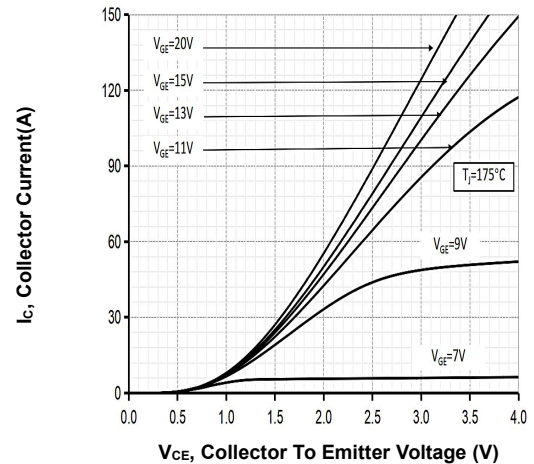

Figure 4. Typical output characteristic
($T_{vj} = 175^\circ\text{C}$)

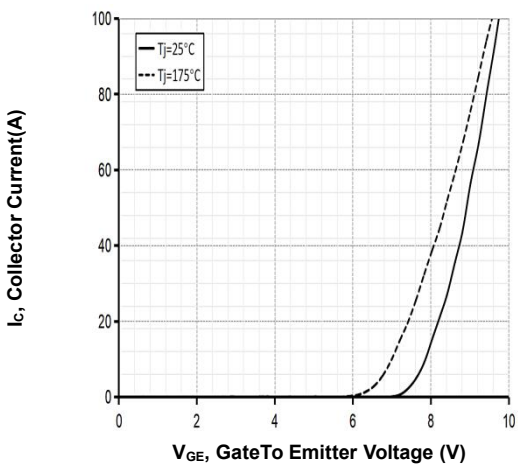

Figure 5. Typical transfer characteristic
($V_{CE} = 20\text{V}$)

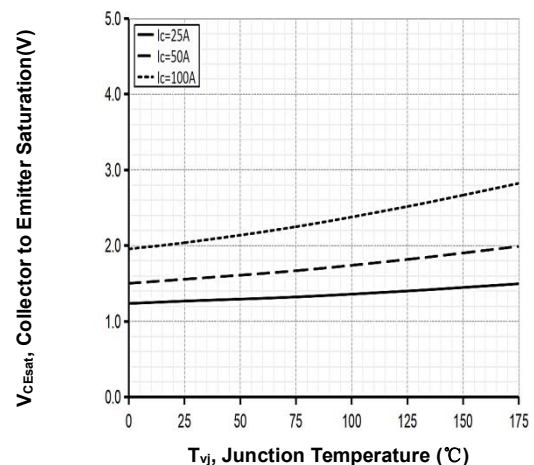

Figure 6. Typical collector-emitter saturation voltage vs. T_{vj} ($V_{GE} = 20\text{V}$)

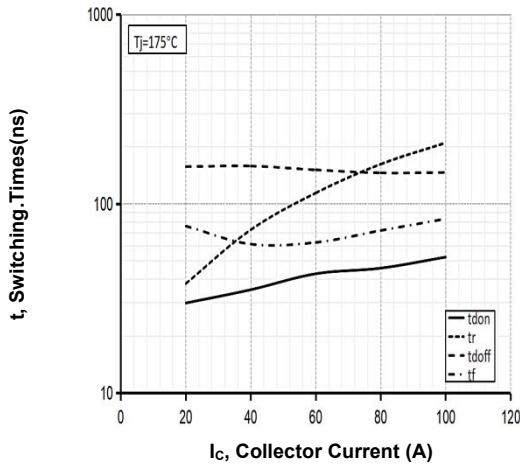

Figure 7. Typical switching times vs. collector current (Ind. load, $T_{vj}=175^{\circ}\text{C}$, $V_{CE}=400\text{V}$, $V_{GE}=15/0\text{V}$, $R_G=10\Omega$)

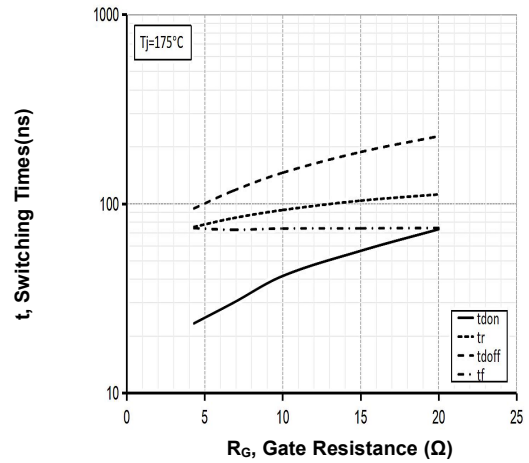

Figure 8. Typical switching times vs. gate resistor (Ind. Load, $T_{vj}=175^{\circ}\text{C}$, $V_{CE}=400\text{V}$, $V_{GE}=15/0\text{V}$, $I_C=50\text{A}$)

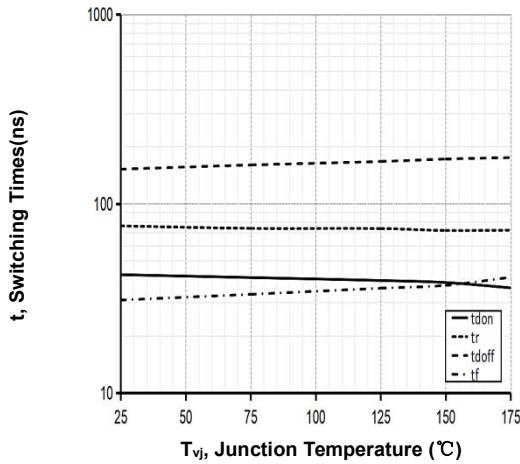

Figure 9. Typical switching times vs. T_{vj} (Ind. Load, $V_{CE}=400\text{V}$, $V_{GE}=15/0\text{V}$, $I_C=50\text{A}$, $R_G=10\Omega$)

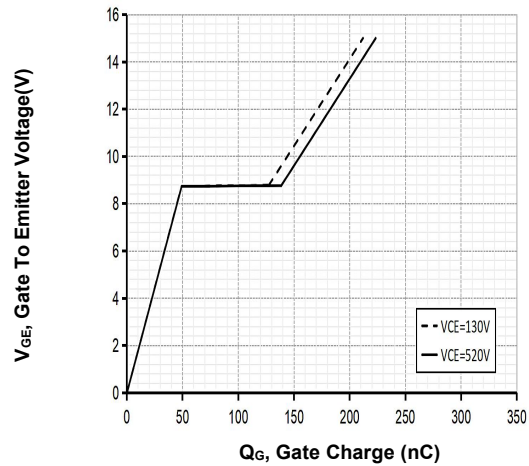

Figure 10. Typical gate charge ($I_C=50\text{A}$)

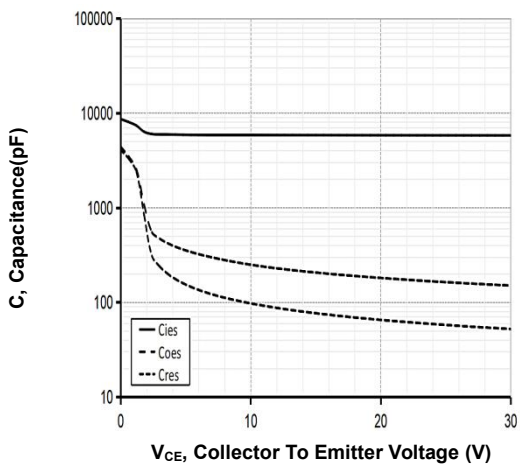

Figure 11. Typical capacitance vs. collector-emitter voltage ($V_{GE}=0\text{V}$, $f=1\text{MHz}$)

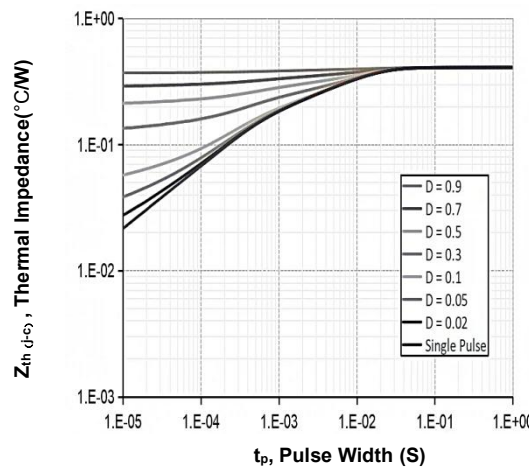

Figure 12. IGBT transient thermal impedance ($D=t_p/T$)

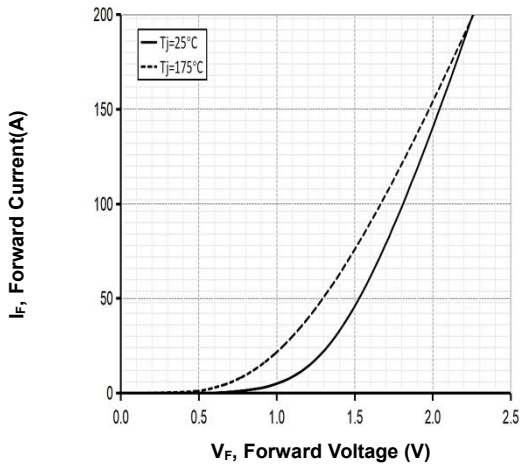

Figure 13. Typical diode forward current vs. forward voltage

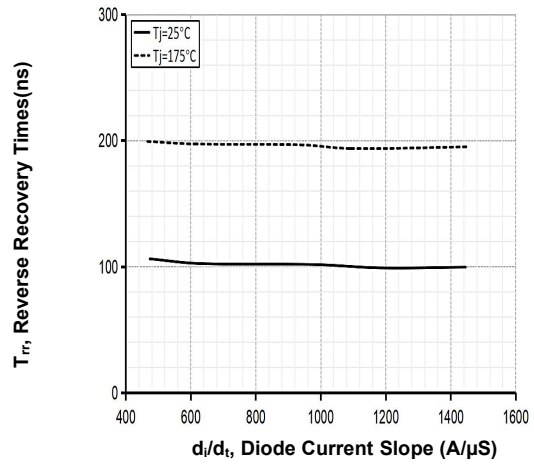

Figure 14. Typical reverse recovery time vs. diode current slope ($V_R = 400V$)

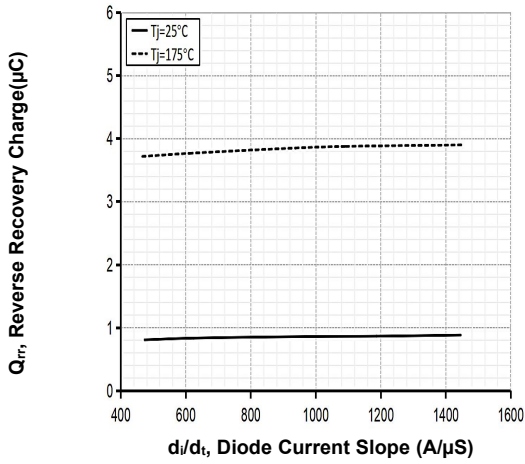

Figure 15. Typical reverse recovery charge vs. diode current slope ($V_R = 400V$)

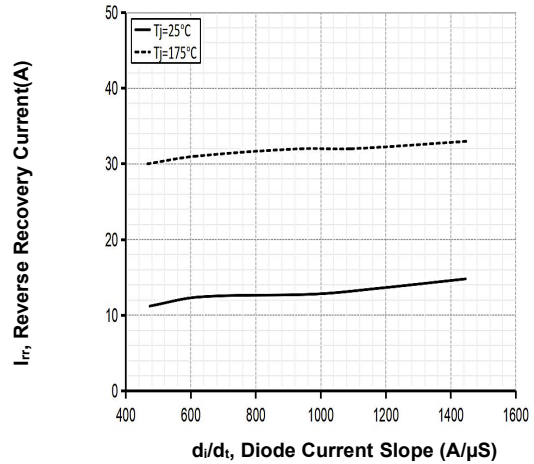
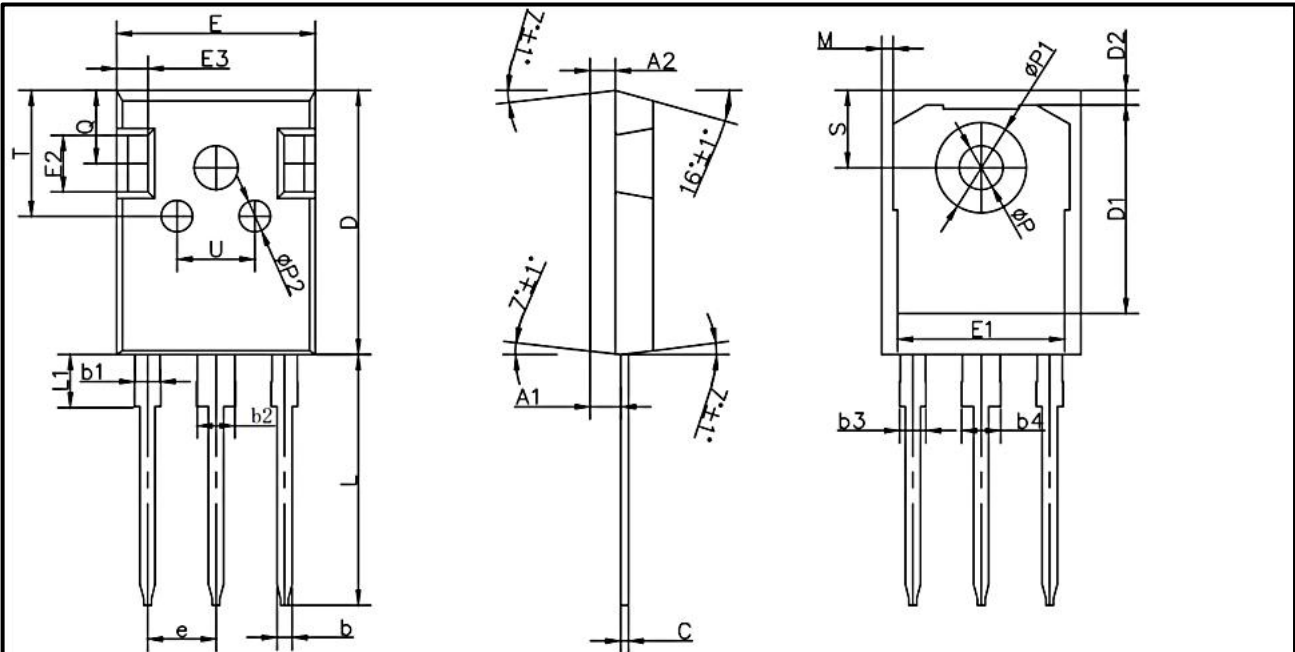

Figure 16. Typical reverse recovery current vs. diode current slope ($V_R = 400V$)

TO247-3 Package Outline



TO247-3L			
DIM.	MIN.	NOM.	MAX.
A	4.90	5.00	5.10
A1	2.25	2.36	2.51
A2	1.90	2.00	2.10
b	1.16	1.20	1.26
b1	1.96	2.00	2.06
b2	2.96	3.00	3.06
b3	-	-	2.25
b4	-	-	3.25
c	0.59	0.60	0.66
D	20.90	21.00	21.10
D1	16.25	16.55	16.85
D2	1.05	1.17	1.35
E	15.70	15.80	15.90
E1	13.10	13.26	13.50
E2	4.40	4.50	4.60
E3	2.40	2.50	2.60
e	5.436BSC		
L	19.80	19.90	20.10
L1	-	-	4.30
M	0.35	0.89	0.95
P	3.40	3.50	3.60
P1	7.00	7.20	7.40
P2	2.40	2.50	2.60
Q	5.60	5.80	6.00
S	6.05	6.15	6.25
T	9.80	10.00	10.20
U	6.00	6.20	6.40

All dimensions in millimeters



DKW50N65DX7

CoolFAST™ Series Seventh Generation

Revision History

Revision	Date	Subjects (major changes since last revision)
0.1	2023-07-20	Target version
1.1	2023-08-15	Preliminary version
1.2	2023-09-08	Sample version
1.3	2024-2-21	MP version

The information given herein shall be not regarded as a guarantee of conditions or characteristics . For any examples, hints or any typical values stated herein and/or any information regarding the application of the product, Drvtek hereby disclaims any and all warranties and liabilities of any kind, including without limitation warranties of non-infringement of intellectual property rights of any third party.

In addition, any information given herein is subject to customer's compliance with its obligations stated herein and any applicable legal requirements, norms and standards concerning customer's products and any use of the product of Drvtek in customer's applications.

The data contained herein is exclusively intended for technically trained staff. It is the responsibility of customer to evaluate the suitability of the product for the intended application and the completeness of the product information given herein for such application.

For further information on the product, technology, delivery, conditions and prices please contact Drvtek (www.Drvtek.com).

Warnings

Due to technical requirements products may contain dangerous substances. For information on the types in question please contact Drvtek.

Except as otherwise approved by Drvtek in a written document, Drvtek products may not be used in any applications where a failure of the product or any consequences of the use thereof can reasonably be expected to result in personal injury.